

Product Guide

Advanced solutions & better usage of raw material

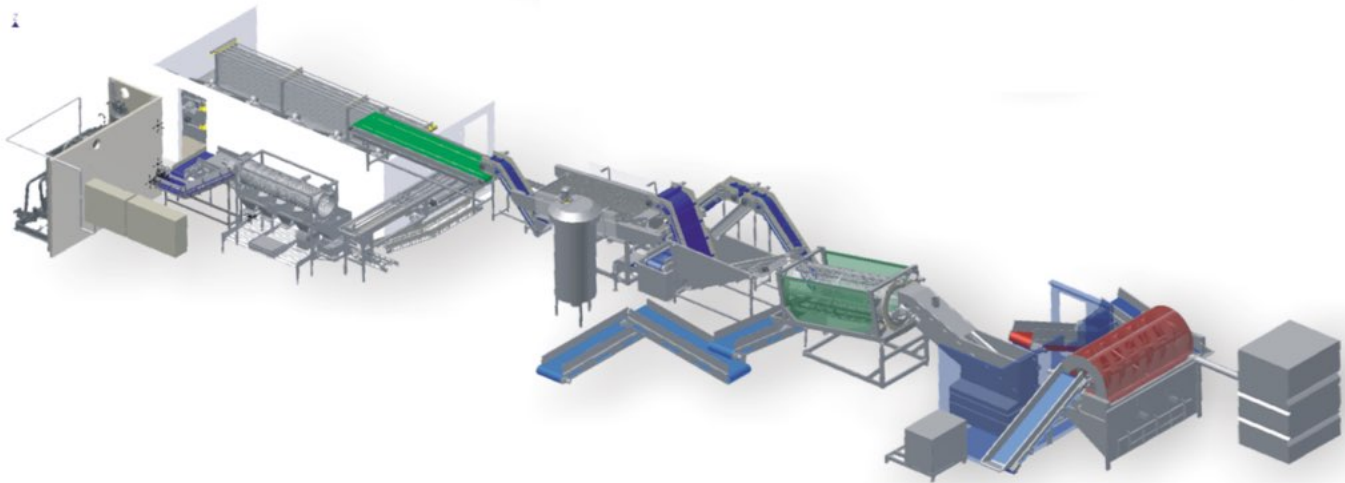
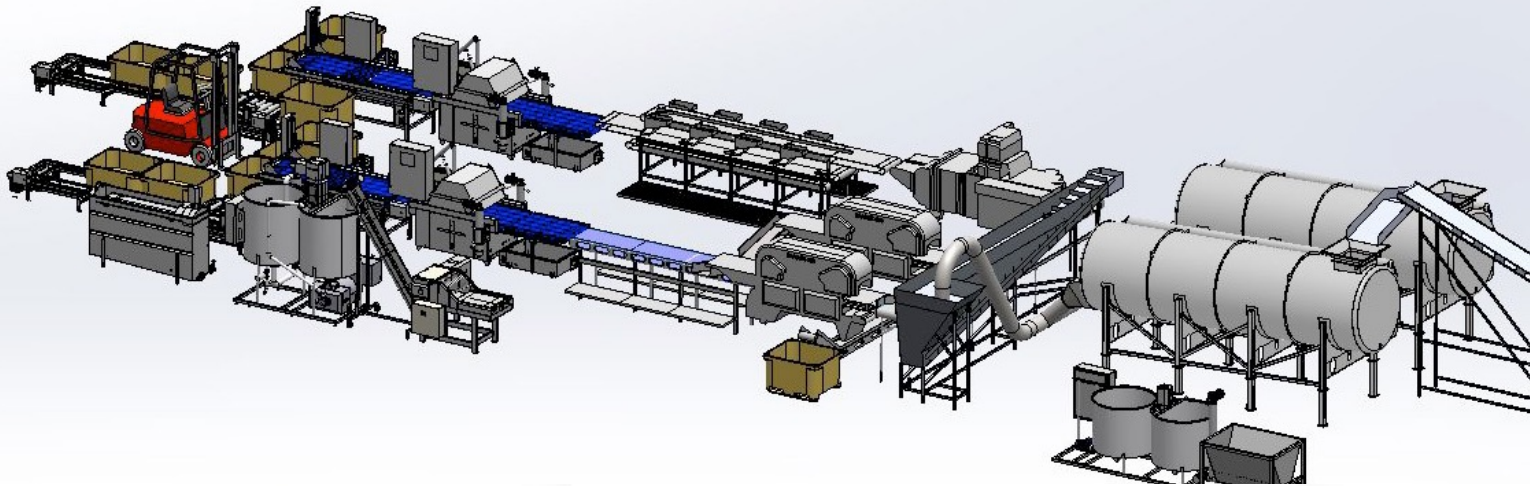

“Fish in Fish” or “Meat in Meat”

Protein-Tec is our system for producing a suspension using undervalued trim and reintroducing it to the fish or meat via Injection. This results in greater yield and profit by increasing green weight and producing a high quality, consistent product. For more info request our “Easy-Inject” brochure

Injection System



TR - 850 Injecting machine with 968 needles

For most fish species, meat and poultry. You can increase yield by 5 to 30% by injection. Good for Brine, 'Fish in Fish' protein, 'Meat in Meat' protein, curing and spice injection. Low maintenance, has no chains, valves or springs. Easy to clean and sanitize.



Protein-Tec

Is our system for producing a suspension using undervalued trim and reintroducing it to the fish or meat via Injection. This results in greater yield and profit by increasing green weight and producing a high quality, consistent product. For more info request our "Easy-Inject" brochure.



Traust Know How, Cryolator, vertical swept surface heat exchanger, offer the ultimate in liquid process chilling.

Conceived for the Protein fish & meat industry to control micro bacteriological counts, protein chilled to and maintained at a specific temperature has proven to be a key factor in consistent protein.



Easy-Brine Chiller

Conceived for the Protein fish & meat industry to control micro bacteriological counts, protein chilled to and maintained at a specific temperature has proven to be a key factor in consistent protein.

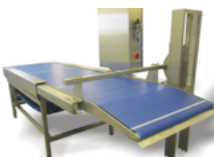

Easy-Layer

Automatic laying system for injection machines

When producing salted fish or meat, the Easy-layer can be used with automatic tub system, that is used after the brine or salt solution has been injected in to the products.



Easy Brine Mixing System

Advanced online brine mixing solutions

We custom make the Easy brine making equipments for customer need and specification.



Easy Flaker

Heavy duty industrial frozen block flaker with screw conveyor. Rugged flaking machine with fast & simple process. Multi product flaker with small footprint



Easy Remote Manager

Easy Remote Manager provides the complete solution for acquiring Weight, Count, Size, Color, and other data from the processing plant floor to the office to optimize Profits and Enhance overall Production Performance.

Salt & Curing System

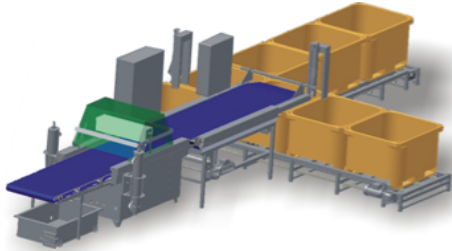

Easy Brine Mixing System

Advanced online brine mixing solutions

We custom make the Easy-brine making equipments for customer need and specification.

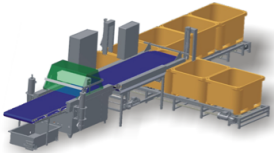

Automatic Tub System

Advanced solutions for salt processing

TR - 850 Injector with Easy Layer & Automatic tub changing system. When producing salted fish or meat, the automatic tub system is used after the brine or salt solution has been injected into the product.



Tub Tipper Advanced solutions for food processing

Tub Tipper is an addition to the salt spreader system. It can also be used for salt re-use and to get better usage of the salt.



Advanced Salt Spreader System

Increase speed spreading grain salt on the split fish, when making salted fish (Bacalao)



Advanced Food Screw Conveyors

That can be used for grain salt, Ice cubes, Bread crumbs, Grain, Corn, Flower or fish and mead offal. We custom build each screw conveyor to customer need and specification.



Salt Removal System

The Salt Removal system removes the salt at the same time the fish is graded. the salt that is removed can be re-used

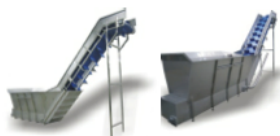

In-Feed Buffers

Available is huge variety of In-feed buffers for any application in the food processing industry.



Pelagic Plants

We offer total solutions for Pelagic processing plants

Grading, Cutting & Packing

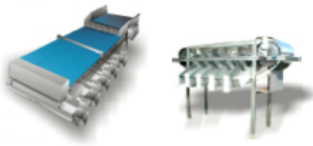

Easy Grader

We offer channel grader for most application in the fish processing industry. The Easy Grader can be used to grade following: Anchovies, Butterfish, Capelin, Catfish, Hake, Herring, Lobster tails, Mackerel, Pollock, Prawns, Redfish, Sardines, Sardinella, Scallop, Shrimp, Sprat, Squid, Trout, Whiting and other species



Easy Compact Grader

We offer the Easy Compact Grader for most application in the fish processing industry. Easy Compact Grader can be used to grade most products in food industry.



Fresh Product Grader

We offer the Fresh Fish Grader for most application in the fish processing industry. The Fresh Fish Grader can be used to grade most products in food industry.

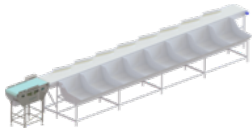

Salt Fish Grader (Bacalao)

We offer the Salt Fish Grader to grade salt fish.



Easy Weight Batcher

We offer Fixed-Weight batching for most application in the food processing industry.



Easy Portioner

Easy Portioner combines True 3D High Accurate Laser Scanning with high Speed Servos to accurately cut products such as fillets or whole fish to desired lengths and weights.



Easy Trimming Lines

We offer flow-lines for any application in the food processing industry. Custom solutions, we custom build each flow-line to customer need and specification.



Easy Trimming & Packing Lines

We offer trimming-lines for any application in the food processing industry with built in Easy Packing Line. We custom build each flow-line to customer need and specification.



Easy Packing Lines

The Easy Packing Lines come in variety of packing-lines for trimming tables and speed packing-line for any application in the food processing industry. We custom build each packing-line to customer need and specification.

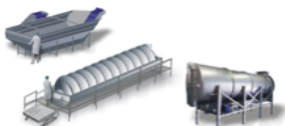

Easy Defrosting System

Water circulating thawing process by tub, tank or spiral thawing system for various products such as cod, haddock, saith, shellfish, pelagic fish etc.

Freezing, Cooling & Glazing

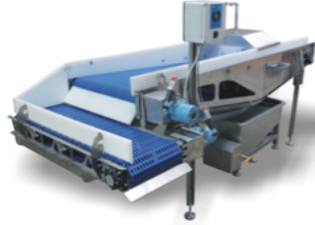

Easy Cooling Machine

Available are Easy Cooling machines for any application in the fish processing industry where fish needs to be cooled while being processed. For examples: Cooling machines are used to keep Scallop and fish filets fresh during processing. Custom solutions.

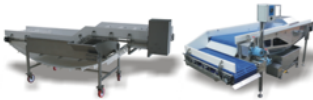

Glazing Machine

Available are Glazing machines for any application in the fish processing industry. Custom solutions, we custom build each glazing machine to customer needs and specification.



Easy Brine Chiller

Conceived for the Protein fish & meat industry to control micro bacteriological counts, protein chilled to and maintained at a specific temperature has proven to be a key factor in consistent protein.



Glycol Cooler

Refrigeration package



IQF Freezing Tunnels

Custom solutions to customer specification.

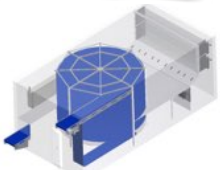

Spiral Freezers

"Single Stacking Spiral Freezers" mounted with a "Space Saver" belt, which is very suitable for fish filets. Custom solutions to customer specification.

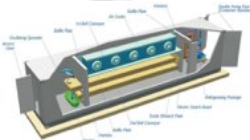

IQF Freezer TR-200-in Self-Contained and Transportable

The equipment is installed in a Standard Insulated 40 foot Ocean Going ISO Container.



Plate Freezer TR-250-in Self-Contained and Transportable

The equipment is installed in a Standard Insulated 40 foot Ocean Going ISO Container. For commissioning, the container must be placed on a level and a firm substrata and



Blast Freezer TR-300-in Self-Contained and Transportable

The equipment is installed in a Standard Insulated 20 foot Ocean Going ISO Container. For commissioning, the container must be placed on a level and a firm substrata and



ICE Maker TR-150-in Self-Contained and Transportable

The equipment is installed in a Standard Insulated 20 foot Ocean Going ISO Container. For commissioning, the container must be placed on a level and a firm substrata and

Fish Drying System

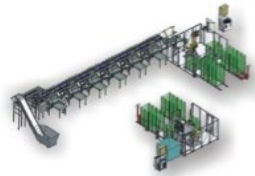
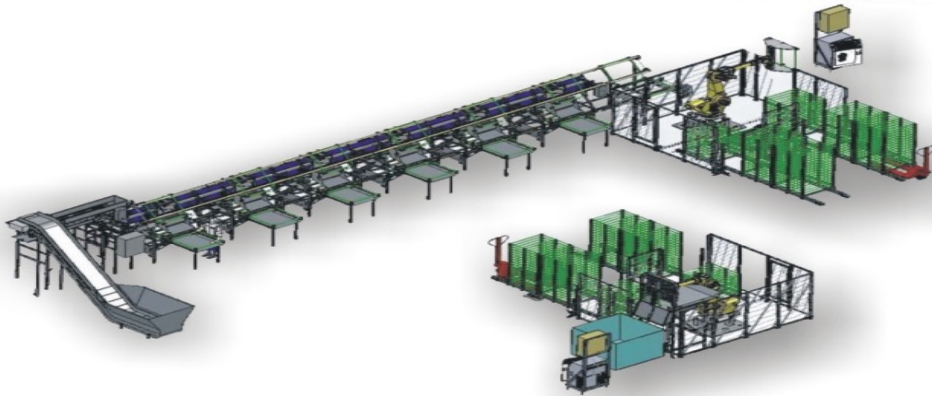

Fish Drying Processing Plant

Fish drying process takes few steps to complete. You can produce dry fish heads, dry fish frames or dry fish cutlets. This is a perfect way to use the raw material and converting it into easily sellable products. After the fish products has been dried it is packed into 30Kg. bags. Turn-key system.



Fish Head Processing line

When processing fish heads for the fish drying process, the heads or fish frames needs to be put onto drying pallets for the drying process.



Drying Pallet

The drying is used to store the fish heads, fish frames or fish cutlets on to dry them. then the dried fish product is loaded into after-drying containers.



Drying Tunnels

The drying tunnels are used to dry the fish heads, fish frames or fish cutlets.

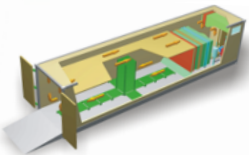

Drying Tunnel in 40ft. HQ. Container

The drying tunnels are used to dry the fish heads, fish frames or fish cutlets.



Stacking & De-stacking Robot

The robot stacks the drying pallets, also it takes the drying pallets from the conveyor and de-stacks them into after-drying container for second drying process before the fish heads or fish frames are sent to the packing press (Stockfish Press).



After Drying Container

The pre-dried fish product is stored in the after-drying containers for further drying process. After drying is complete dried fish product goes to the Stockfish packing press to be packed into bags.



Humid Control

The humid control is used for the drying process when making dried fish heads, dried fish frames or dried fish cutlets. The humid control is the critical factor to making dry fish.

Dry Fish Packing & Stacking



Easy Crusher. Fish Head Crushing Machine

The Easy crusher series, crushes and opens fish heads before the fish head is fed into the drying tunnels.



Model: TR-M100

The Manual Stockfish packing press Packs the dried fish heads, fish frames or fish cutlets into 30 Kg. bags



Model: TR-A1000

The Stockfish packing press takes the dried fish heads, fish frames or fish cutlets and crushes them, then it enters the scale compartment to the packing press, and into 30Kg. bags.



Model: TR-A2000

The Stockfish packing press takes the dried fish heads, fish frames or fish cutlets and crushes them before it goes through the inspection speed conveyor. Then it enters the scale compartment to the packing press. Bag size 30 Kg.



Easy-Container Stacker

The forklift is mounted with the Easy Container stacker to load the container. When Easy Container Stacker is used you can load 10 to 15% more bags into the container then loading it by hand. Saves labor.



Scallop Processing System

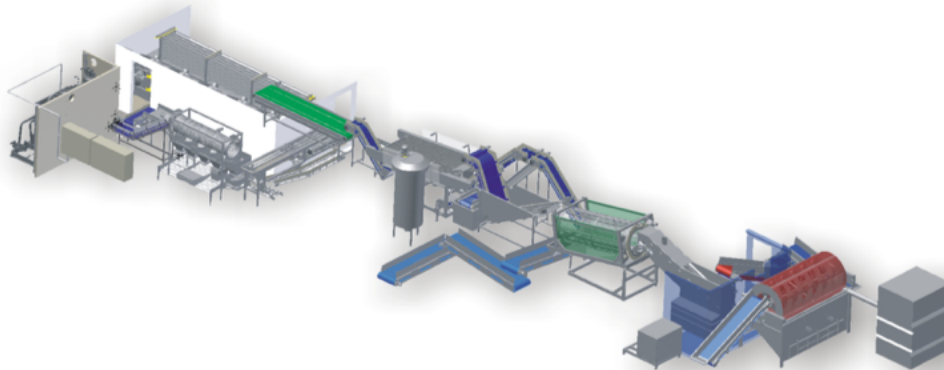

Scallop Processing Plant

Superior Scallop Eviscerator system. The system is a labor saving system with complete solution processing Scallop with increased yield. Our Scallop processing plants have been sold to countries around the world with perfect track record. We can supply land based and on-board Scallop processing plants.



Shell Cooker

The shell cooker steams the shell, then the Scallop is removed from the shell.



Shell Separator

The shell separator separates the Scallop from the shell.



Brine Separator

The Brine separator is the second separation face to separate the shell from the Scallop.



Drum Eviscerator

The Drum Eviscerator is new type Eviscerator to cleans the Scallop, it generates better yield.



Eviscerator

The horizontal flat bed Eviscerator is the traditional method to clean the Scallop.

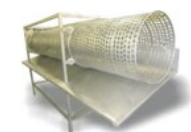

Scallop Size Sorting

The Scallop drum grader is used to grade the Scallop to preferred sizes.



Scallop Grader

The Scallop channel grader is used to grade the Scallop to preferred sizes.

Roe Extraction System



Roe Extraction Plant

Herring and Capelin roe extraction plant, extract the roe caviar from the fish. The system is labor saving system and has Maximum recovery. We custom built each plant for customer application. Available is land based or on-board roe extraction plants.



Cutting Machine

The cutting machine cuts the Herring or Capelin before going through the roe extraction process.

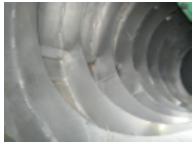

Easy-Sep: Separation - Filtration

Separates solid from Waste water
Filtration of Waste water
Reduces solution in waste water



Drum Filter

The Drum filter cleans the roe.



Easy Float Filter: Separation - Filtration - Floatation

All functions in one compact unit. Small footprint easy to install, the unit is tested and ready to run. Easy to transport. Easy to maintain and clean. Standard units 80m³/h - 50m³/h - 20m³/h - 10m³/h, with or without chemical treatment. Minimal chemical needed after filtration, Innovation in Micro bubble generator saves energy and investment.



Cyclones

The Cyclones separates the roe from the water.



Roe Agitator



Easy Sep Filter

The Easy Sep filter is the last step of cleaning the roe caviar, it separates the water from the roe.



Salmon Roe Equipment

We offer complete processing solution for Salmon roe extraction, and separation of the roe from the sack.

Conveyors & In-feed Buffers



Conveyors

We offer PVC & PE module conveyors for any application in the food processing industry. Custom solutions, we custom build each conveyor to customer needs and specification.



Conveyors

We offer PE module conveyors for any application in the food processing industry. Custom solutions, we custom build each conveyor to customer needs and specification.



Conveyors

We offer PE module conveyors for any application in the food processing industry. Custom solutions, we custom build each conveyor to customer needs and specification.



Easy Conveyor Filters: Wide range of Filtration



Grading modules for channel graders



Screw Conveyors

We offer screw conveyors for any application in the food processing industry. Custom solutions, we custom build each screw conveyor to customer needs and specification.



Screw Conveyors / In-feed Buffer

That can be used for grain salt, Ice cubes, Bread crumbs, Grain, Corn, Flour or fish and meat offal. We custom build each screw conveyor to customer needs and specification. We have available many different sizes of screw conveyors for the food industry.



In-Feed Buffers

Available is a huge variety of In-feed buffers for any application in the food processing industry.



Shrimp Processing plant

We offer complete solution for Shrimp processing plants.

Cleaning & Waste Water Treatment



Box Washing machine

Box washing machine is used to clean and sanitize processing boxes, used in the food industry.



Easy Pipe Pump Sanitary

The pipe pump sanitary is used to pump roe and pumps difficult materials in the food processing industry.



Vacuum cleaning system

Vacuum cleaning system is used to clean blood spots, used in the food industry.



Cleaning Brush System

Cleaning brush system is used when the fish is processed on the trimming table

Waste Water Treatment

Industrial Waste Water Treatment.
New Trend: Treat pollution at the source.
Saves cost , with the benefits of using the By-Product.



Easy Con Filter: Wide range of Filtration

Saves cost by turning the By-product into value. By-product is cleaner (EU Directives).
Cleaner environment.
Higher prices for By-product.



Easy Sep: Separation - Filtration

Separates solid from waste water filtration of waste water reduces solution in waste water.



Easy Float Filter: Separation - Filtration - Floatation

All functions in one compact unit. Small footprint easy to install. the units are tested and ready to run. Easy to transport. Easy to maintain and clean. Standard units 80m³/h - 50m³/h - 20m³/h - 10m³/h, with or without chemical treatment. Minimal chemical needed after filtration, Innovation in Micro bubble generator saves energy and investment.

Product Line



Box Fillers
Box Washing Machines
Brine Mixing System
Capelin Roe Extraction Plants
Caviar Plants
Cleaning Brushes System
Conveyors, Belts & Modulares
Defrosting Systems Tub, Tank or Spiral
Dried Fish Head Packing
Easy Channel Grader
Easy Compact Grader
Easy Packing-lines
Easy Portioner
Easy Layer System
Easy Remote Management
Easy Flaker (Frozen block flaker)
Easy Chiller
Easy Cooler
Easy Container Stacker
Easy Con Filter
Easy Float Filter
Easy Sep Filter
Easy Crusher
Easy Pipe Pump, sanitary
Feeding Buffers
Flow-Lines
Fish Drying Equipment
Freezing IQF Tunnels, Spiral, etc.
Fresh Product Grader (Custom Graders)

Glazing Machines
Graders, belt type
Herring Processing Plants
Herring Roe Extraction Plants
Injecting Machine for Fish and Meat
Pelagic Plants
Protein-Tec "Fish in Fish" "Meat in Meat"
Roe Agitator
Salmon Roe Equipment
Salmon to Salmon Processing System
Salt separators
Salt Fish Grader
Salt Processing Systems
Salt Removal Systems
Salt Spreaders
Scallop Eviscerators
Scallop Processing Plants
Scallop Channel Size Sorting
Scallop Drum Size Sorting
Screw Conveyors
Shell Cookers
Shell Separators
Shrimp Processing Plants
Trimming-lines
Tub Handling Systems
Tub Tippers
Vacuum Cleaning System
Waste Water Treatment
Weight Batcher



"Salmon in Salmon"



Split Cod injection



Salt processing system



Dry fish head packing



Easy trimming line



Easy packing line



Scallop processing plant



On board roe extraction

Optimize your investment with custom-made solutions

Traust technology, LLC., has been a leader in the development of processing equipment for over 30 years. Our qualified team of engineers, with years of experience, has designed, developed and installed complete processing plants as well as stand alone systems to suit the exact needs of processors around the world

